









PARTS & ASSEMBLY SHEET

Fixture Name: AFJBI-S

This fixture assembled PO: _____ Date: _____

Notice: Please review the parts listing and check for all parts before assembling the fixture. If any parts are missing or damaged, please note on this sheet and contact the place of purchase to arrange for replacement parts.

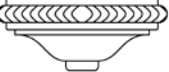
PARTS LIST

Cross Mounting Strap 1ea 100*95mm		Wire Connector 3ea P3 Orange		Glass 1ea	
Fixture Mounting Screw 2ea		Mounting Screw 2ea 8/32 * 1"		Acorn Nut & Gasket Washer 2ea	
Bottom Cap 1ea		Finial 1ea		Nipple 1ea	
Part Needed:				Quantity:	
Part Needed:				Quantity:	
Reason why: (missing, scratched, broken glass, bent, bad finish)					
Comments : This product is twin packed, so parts in the list are for two lamps					

FIXTURE ASSEMBLY INSTRUCTIONS

Read and review installation instruction sheet before assembling the fixture.

1. Install the light bulb in accordance with the fixture's specifications.
DO NOT EXCEED MAXIMUM WATTAGE RATING!

2. Raise the Glass (C) and Bottom Cap (D), around the connection Tube (B) to seat firmly on Body (A), finally secure in place with the Finial (E).

NOTE: INSTALL THE GLASS ASSEMBLY AFTER THE FIXTURE IS HUNG.

AFJBI-S

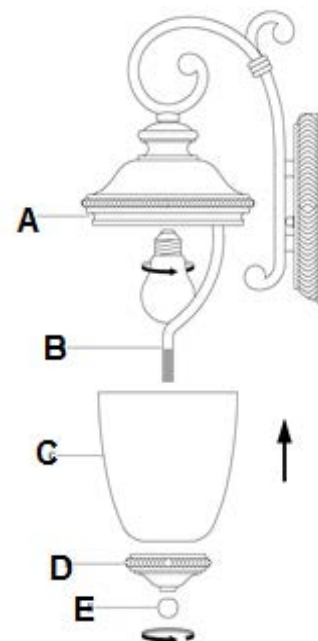

For Customer Service, contact Toll Free: 800.277.0979 Ext. 0 or Email:
service@laureldesigns.biz to arrange for replacements or parts.

Please have your purchase order number from your packing slip available as proof of purchase.

INSTALLATION INSTRUCTIONS

Fixture Name: AFJBI-S

For Outdoor Fixture

WARNING ! SHUT OFF POWER AT FUSE OR CIRCUIT BREAKER.

HANGING THE FIXTURE (Fig 1)

1. Carefully remove the new fixture from the carton and the yellow bag that holds your parts. Check that all parts are included. Please reference the illustrations and the Parts and Assembly Sheet.
 2. Shut off power at the circuit breaker and completely remove the old fixture from wall, including the old mounting strap.
 3. Unscrew the Acorn Nuts (F), take off the Gasket (G), and remove the Mounting Strap (B) from Back Plate (E).
- *Be careful to not misplace the parts.
4. Place Mounting Strap (B) over the Junction Box so that Fixture Mounting Screws (C) are horizontal.
 5. Attach the Fixture Mounting Strap (B) to the Junction Box using Mounting Screws (A). Tighten Mounting Screws (A) securely with a screw driver.

Fig. 1

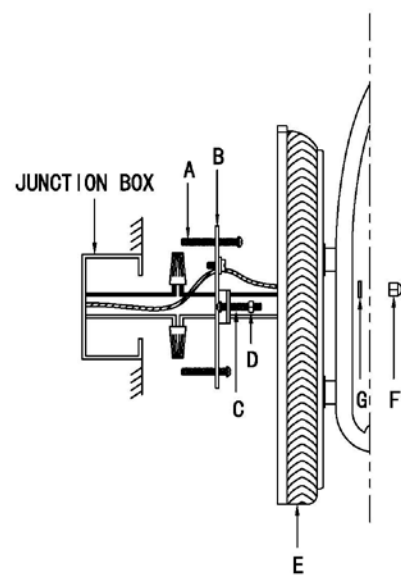

CONNECTING THE WIRES(Fig 2)

6. Attach the power supply wires to the fixture lead wires by connecting BLACK to BLACK (or SMOOTH) and WHITE to WHITE (or RIBBED).
 7. Ground wire connection: Connect fixture ground wire to house ground wire, which usually has green or copper insulation, with the correct size of wire connector. If there is no house ground wire at ceiling junction box then attach fixture ground wire securely onto green grounding screw located on the mounting bar.
- NOTE: Twist the wires together in the same direction that you twisted the wire connector onto the wires.**
8. Tuck the wire connections neatly into the Junction Box.

Fig. 2

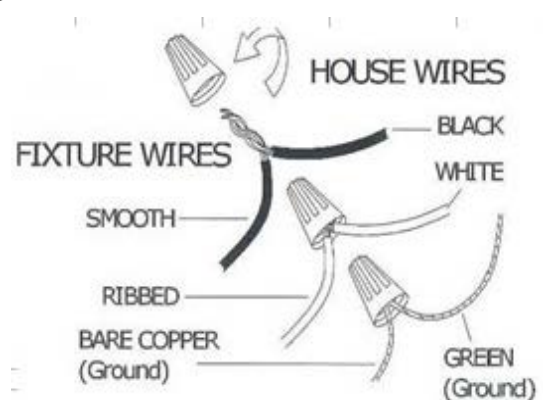

FINISHING THE INSTALLATION(Fig 3)

9. To prevent moisture from entering the Junction Box and causing a short, use clear caulking (i.e. indoor/outdoor silicone sealant) to outline the outside of the fixture's back plate where it meets the wall leaving a space at the bottom to allow any moisture to escape. (Fig.3)
 10. Place the Back Plate over the two Mounting Screws (C), then place Gasket (G) over the screws and secure Back Plate (E) against the wall by threading Acorn Nuts (F) onto the Mounting Screws (C) until snug against the wall. (Fig 1)
 11. Install the light bulb and glass frame as per the fixture and assembly sheet.
- YOUR INSTALLATION IS NOW COMPLETE. RETURN POWER TO THE JUNCTION BOX AND TEST THE FIXTURE.**

Fig. 3

