

# Assembly Instructions: 9903-WSC (Autumn Twilight)

## IMPORTANT:

- ALL INSTALLATION WORK SHOULD BE DONE BY ACCREDITED PROFESSIONAL.
- SHUT OFF POWER SUPPLY AT FUSE OR CIRCUIT BREAKER!
- USE ONLY THE SPECIFIED BULBS. DO NOT EXCEED THE MAXIMUM WATTAGE!

For Customer Service, please contact the place of purchase.

## PREPARING FOR INSTALLATION

Remove all of the contents from the carton. See the important notes above. Shut off the power at the circuit breaker and completely remove the old fixture from the wall, including the old mounting strap.

1. Mounting strap (B) may be attached to backplate (F). If the mounting strap is attached, unscrew deco nuts (H) to detach. The mounting strap contains several pairs of threaded holes. Find the pair of holes that matches the spacing of the holes on the junction box and your fixture's backplate. Mounting screws (D) should be attached to mounting strap (B) with nuts (C). Test backplate (F) on mounting strap (B) to ensure that when the backplate is over the mounting strap, mounting screws (D) will come through with enough threads exposed for deco nuts (H) to fit in place. Set the fixture aside. Pull your house's wires through the center of mounting strap (B).
2. Place mounting strap (B) over the junction box so that mounting screws (A) may be inserted. Secure mounting strap (B) to the junction box with mounting screws (A) and a screwdriver. Tighten the screws securely.

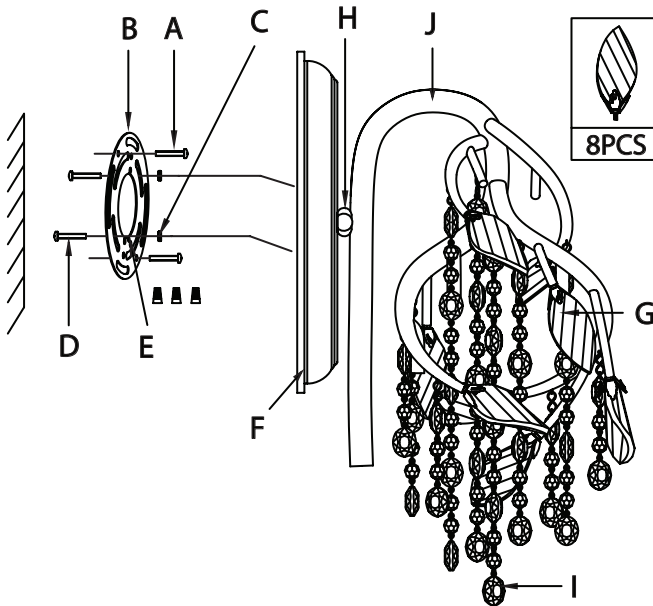

How to Identify the Fixture's Wires		
Hot	Neutral	Ground
Smooth	Ribbed	Bare Metal, Green, or Green Inner Thread
Black	White	
Black Inner Thread	White Inner Thread	

## CONNECTING THE WIRES

3. Attach the fixture's wires to the power supply wires from the junction box. Connect black to black (or smooth); white to white (or ribbed); ground to ground (green or copper). Twist the ends of the wire pairs together, then twist on a wire connector. Make sure all twists are in the same direction. If there is no ground wire (green or copper) from the junction box, locate ground screw (E) on the mounting strap and wrap the fixture's ground wire around the green ground screw (E). Use a screwdriver to secure ground screw (E) onto the mounting bracket. Tuck all wires neatly into the junction box.

## FINISHING THE INSTALLATION

4. Push the backplate up to the wall so that screws (D) protrude through the holes in the backplate. Secure the backplate to the wall by threading decorative nuts (H) onto the threads of screws (D).
5. Install the crystals. To properly install crystals leaves (G), flip the page and refer to the attached crystal diagram.
6. Install light bulbs (not provided) in accordance with the fixture's specifications. Do not exceed the maximum recommended wattage.

Your installation is now complete. Turn on the power and test the fixture.

### CLEANING TIPS





Treat the fixture gently! Regular cleaning will reduce the need for deep cleaning. For regular cleaning, turn off the light and wipe down the fixture with a clean lint-free cotton or microfiber cloth. Never spray cleaner directly onto the fixture. Dry with a lint-free or microfiber cloth.

# Assembly Instructions: 9903-WSC (Autumn Twilight) - continued

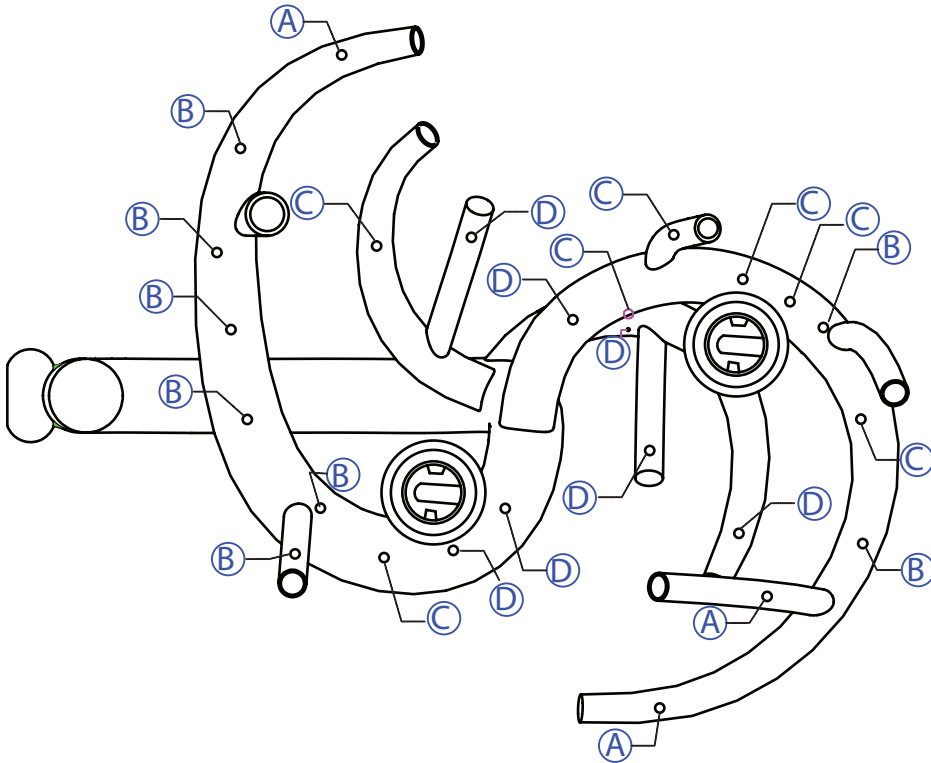
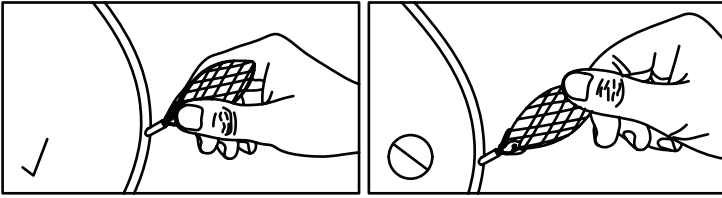
## CRYSTAL DIAGRAM

Screw crystal leaves (G) onto the empty screw posts on the fixture body. Refer to the diagram demonstrating how to hold crystal leaves (G) carefully by the metal base to prevent the crystals from cracking or breaking. The crystal beads are tied up in bags on the fixture body. Carefully tear open the bags and arrange the strings of beads.



<p>9903-WSC</p> <p>A-- PT-CRYSTAL-9903-2B                  B-- PT-CRYSTAL-9903-3B                  C-- PT-CRYSTAL-9903-4B                  D-- PT-CRYSTAL-9903-5B</p>	<p>(A)</p> 	<p>(B)</p> 	<p>(C)</p> 	<p>(D)</p> 
	X3	X8	X7	X7