

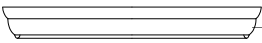







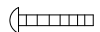

PARTS & ASSEMBLY SHEET

Fixture Name: Lancaster 6005-10 PW/RBZ

This fixture assembled PO: _____ Date: _____

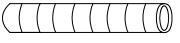
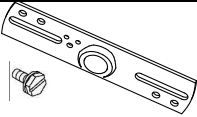
Notice: Please review the parts listing and check for all parts before assembling the fixture. If any parts are missing or damaged, please note on this sheet and contact the place of purchase to arrange for replacement parts.

PARTS LIST		Company Name: _____ Co. Account #: _____ to be filled out by retailer	
Canopy  1ea 10"x 4.5"	Wire connectors  2ea P3 Orange	Canopy loop  2ea @3/8 x 29mm	
Chain  2ea 6ft x3.8mm	Junction Box Screw  2ea 8/32" x 1"	Socket Washer  3ea @55 x 1mm	
Chain connector  2ea @4X55mm	Deco nut  1ea @15 x 12mm	Nipple  1ea @3/8 x 45mm	
Mounting Strap w/ ground screw  1ea 3/4"X4"	Hex Nut  2ea @3/8 x 3mm	Spring Washer  1ea @15 x 3mm	
Part Needed _____	Quantity _____		
Part Needed _____	Quantity _____		
Reason why _____	(missing, scratched, broken glass, bent, bad finish)		
Comments _____			

FIXTURE ASSEMBLY INSTRUCTIONS

Read and review installation instruction sheet before assembling the fixture.

ASSEMBLING THE FIXTURE (Fig. 1)

1. By measuring determine correct number of links needed for proper hanging height. Use a pair of pliers to open one link of the Chain (I) then remove the excess chain (I) and discard it.

NOTE: INSTALL THE GLASS ASSEMBLY AFTER THE FIXTURE IS HUNG.

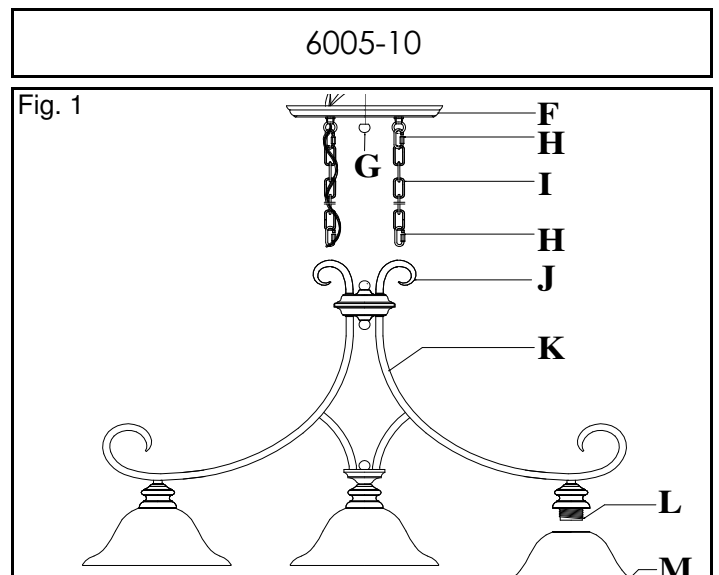

For Customer Service, contact the place of purchase to arrange for replacement parts.

PARTS & ASSEMBLY SHEET

Fixture Name: Lancaster 6005-10 PW/RBZ

2. Use Chain connector (H) to attach the Chain (I) to top curve of fixture Frame (J) and close the connector as shown.

3. Attach a Chain connector (K) to the top end of the Chain (J). Repeat steps 1 thru 3 for the second chain.

4. Lace the fixture's wire through the chain links (I) (every three links) and pull until taut. (the wires will run through just one side.)

5. Use Chain connector (H) to attach the top of Chain (I) to the Canopy loop (A2) and close the chain connector as shown.

6. Tread the fixture wires through the center hole in Canopy loop.

7. Make sure the weight of the chandelier will be supported by the chain-not the electrical wire.

* You may now install the fixture.

Note: Complete these remaining steps after the fixture is hung.

8. Place the Glass Shades (M) over the Threaded Sockets (L), secure the Glass Shades (M) by threading by the Socket Rings (O) over the socket washers (N) until tight.

9. Install the light bulbs in accordance with the fixture's specifications.

(DO NOT EXCEED MAXIMUM WATTAGE RATING)

Fig 2

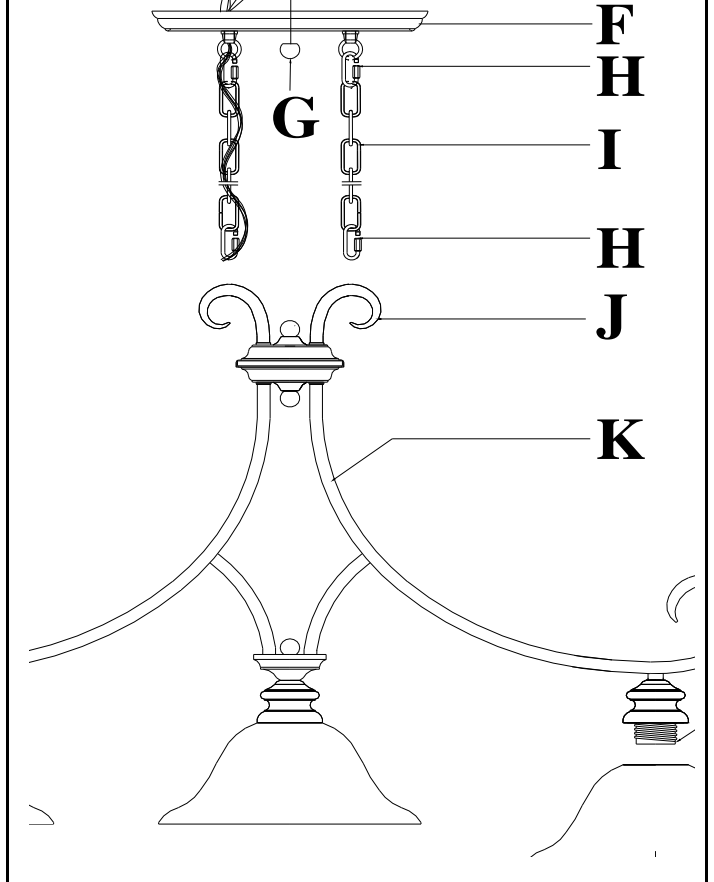
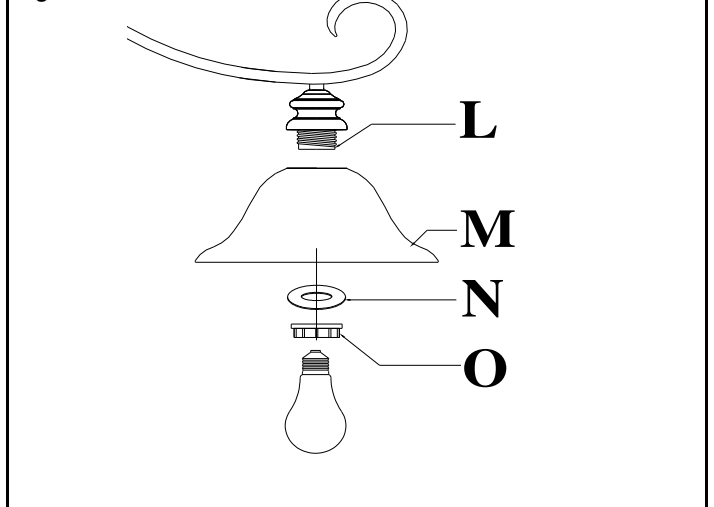

Fig 3



For Customer Service, contact the place of purchase to arrange for replacement parts.

WARNING ! SHUT OFF POWER AT FUSE OR CIRCUIT BREAKER.

HANGING THE FIXTURE (Fig.1)

1. Carefully remove the new fixture from the carton and the yellow bag that holds all parts. Check that all parts are included as shown in the illustration and parts list.
2. Shut off the power at the circuit breaker and remove old fixture from ceiling, including the old mounting strap.
3. Thread end of the Nipple (C) into Mounting Strap (D).
4. Place Lock Washer (B) over end of Nipple (C) protruding through Mounting Strap (D) and thread Hex Nuts (A) onto Nipple until tight.
5. Take this mounting strap assembly and mount to ceiling junction box with junction box Screws (E). Tighten screw securely with screw driver.
6. Take the canopy and pass over the Canopy loop. approximately one half of the canopy loop exterior threads should be exposed. Adjust until desired height is reached. *the Canopy loop collar should fit snugly on the Canopy loop after the canopy is installed. Remove Canopy and Canopy lock collar.
7. Assemble the fixture and have an assistant or secure support hold the weight of the fixture while you complete the wiring connections.
8. Thread the fixture wires and ground wire of the assembled fixture through one of the the canopy loops and nipple and into the outlet box.

CONNECTING THE WIRES (Fig 2)

9. Attach the power supply wires to the fixture lead wires by connecting BLACK to BLACK (or SMOOTH) and WHITE to WHITE (or RIBBED).
10. Attach the GROUND wire(GREEN or COPPER) from the Junction Box and the fixture Ground wire to the green Ground Screw on the Mounting Bracket (D) or connect both wires together using the correct size of wire connectors.

NOTE: Twist the wires together in the same direction you twist the wire connector onto the wires.

11. Tuck these wire connections neatly into the Junction Box.
12. Raise Canopy (F) to the ceiling and secure in place by threading the Deco nut (G) onto the Nipple (C).
13. Install the light bulbs and glass shade as per the fixture assembly sheet.

Fig. 1

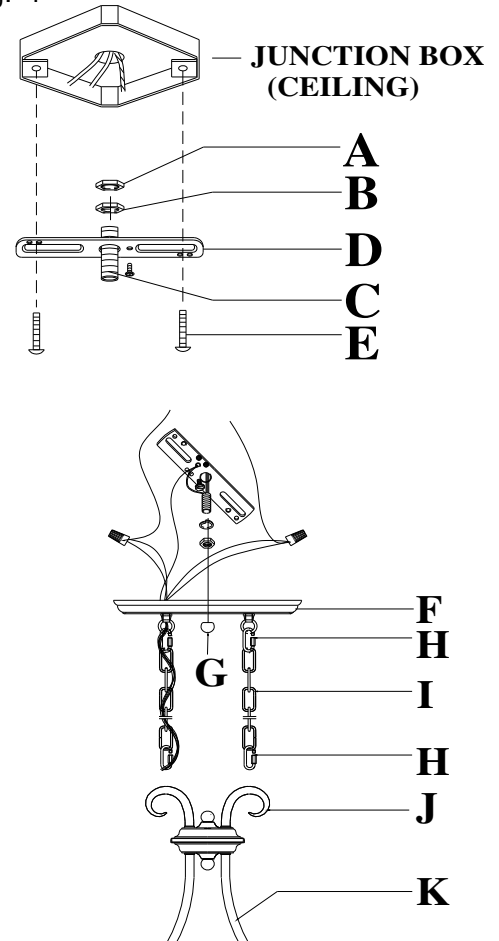
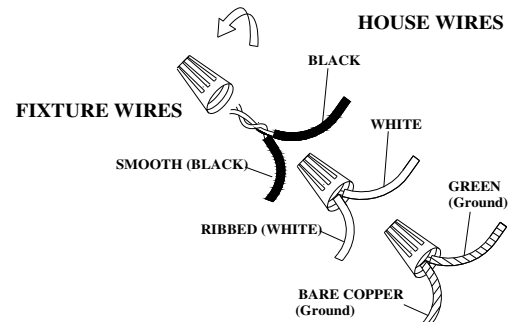

Fig. 2



**YOUR INSTALLATION IS NOW COMPLETE.
RETURN POWER TO THE JUNCTION BOX
AND TEST THE FIXTURE.**